

Arnie Metal Clothes Rail

Assembly Instructions - Please keep for future reference

ARNI-CR-AW16-A

Dimensions

Width - 80 cm
Depth - 44 cm
Height - 147cm

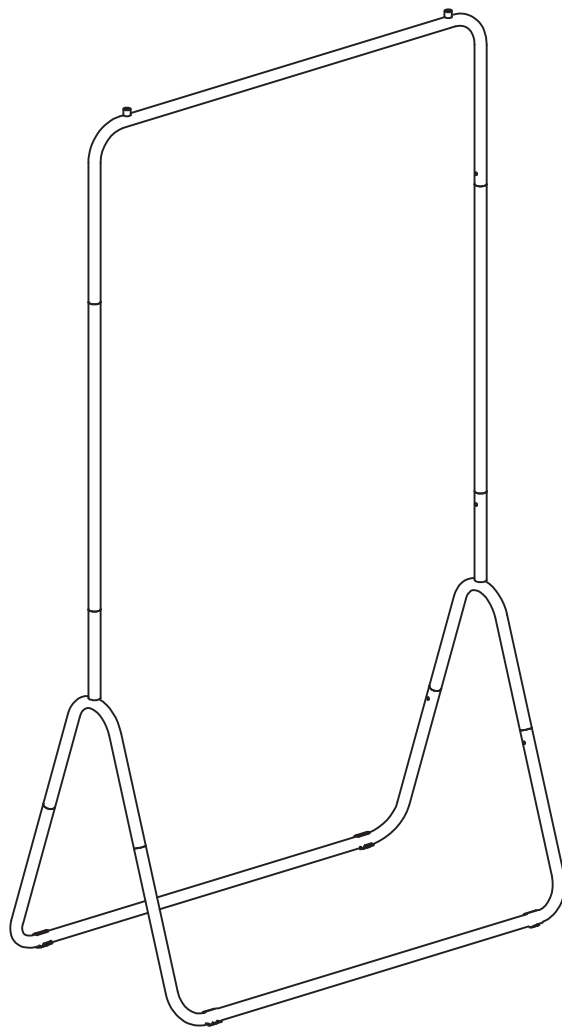

Important! - Please read these instructions before assembly

If you need help or have damaged or missing parts, email:
customerservices@habitat.co.uk or call: **0344 499 4686**

habitat 



Safety and Care Advice

Important! Please read these instructions fully before starting assembly

DO NOT TIGHTEN UNTIL ALL PARTS ARE IN POSITION.

Plan to assemble the furniture as near as possible to the place you intend it to be used.

Do not place your furniture directly in front of radiators, fires, or any source of direct heat.

Ensure that the surface on which you are assembling furniture is clean and flat.

Before commencing assembly, please identify all components.

Do not discard the packaging until the unit is fully assembled to ensure that no fittings or components are disposed of.



Maximum recommended load 25kg.
Distribute weight evenly along rail.

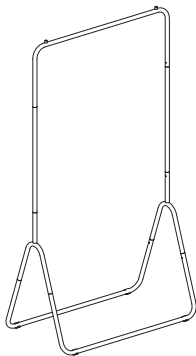

General information

If for any reason you should have problems with your Habitat product, please contact the store from which you purchased it.

Please retain your receipt as proof of purchase.

If you have any comments or suggestions regarding this product, assembly instructions or service

received, please contact the store or Habitat Head Office via its web site: www.habitat.co.uk or write directly to: Habitat Retail Ltd. 489-499 Avebury Boulevard, Milton Keynes MK9 2NW

Components-Panels

If you need help or have damaged or missing parts, email: customerservices@habitat.co.uk or call: 0344 499 4686

Please check you have all the panels listed below

Note: There are 'Batch Code' labels where shown on the indicated items, these should be retained.



A 2pcs

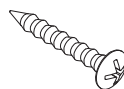

B 9pcs

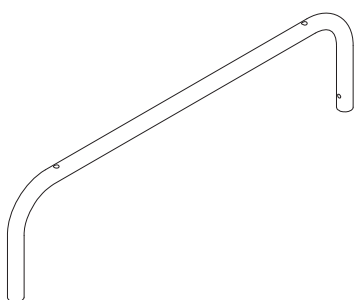

C 1pc

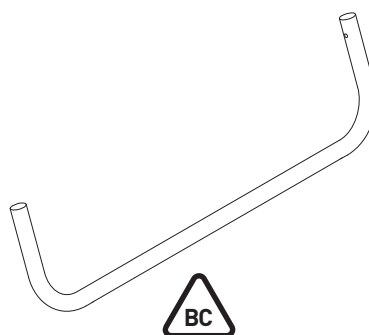

D 2pcs

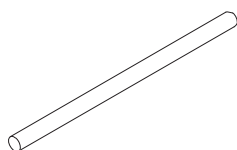

E 2pcs

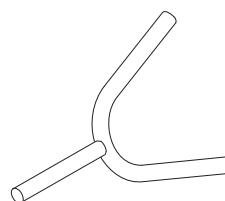

F 2pcs

Assembly Instructions

Step1

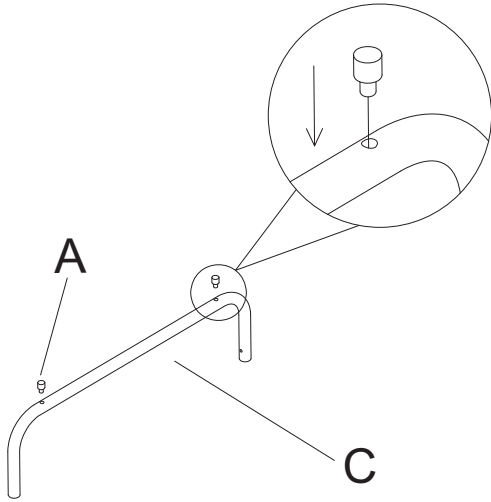

Step2

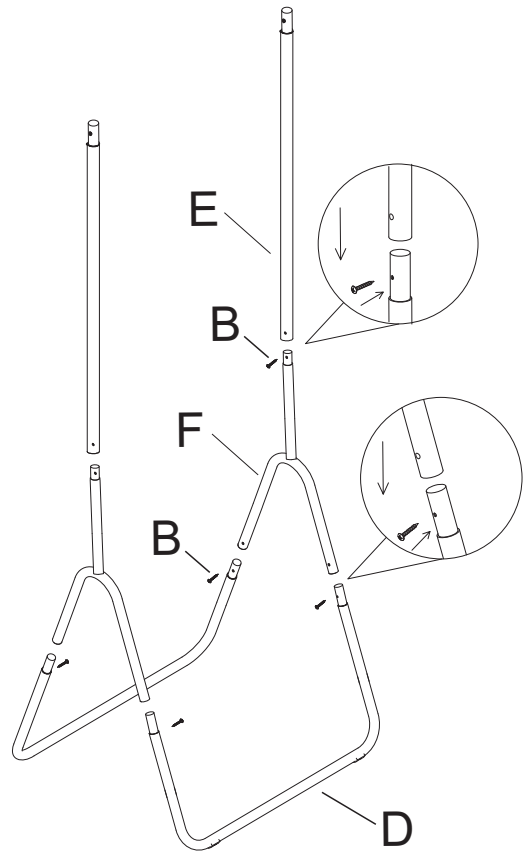

Step3

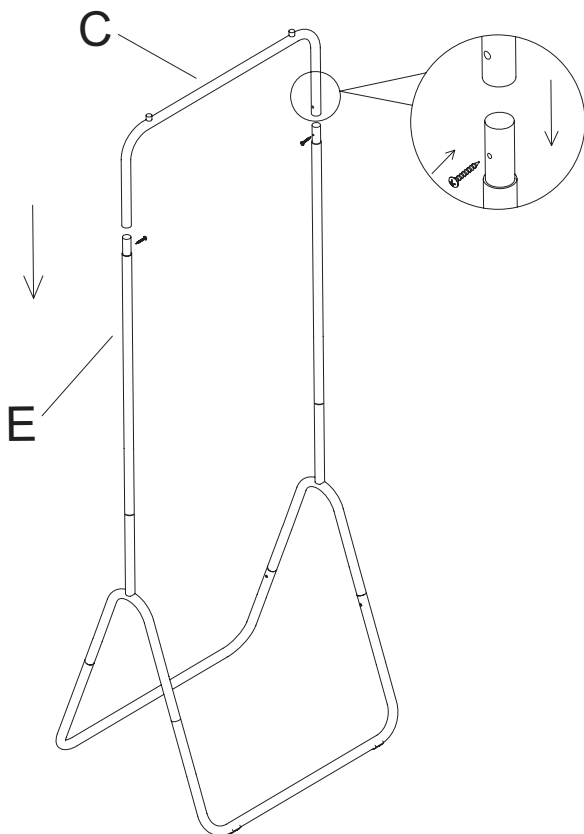

Step4

